

bluwater
eat + drink

kids

Only available for children under 12

Breakfast (served till 12pm)

Coco Pops, Rice Bubbles or Cornflakes 4.0
Toast with jam, honey, peanut butter or vegemite 3.0
Fresh daily baked muffins 4.0
Eggs (scrambled, fried or poached) with toast 5.5
Eggs (scrambled, fried or poached) with toast and bacon 6.5
Porridge with banana 6.0
Fruit salad with yoghurt and honey 6.0
Kids pancakes with maple syrup 6.5
Side of sausage 2.5
Side of hash brown 2.5

Lunch & Dinner

Cheese and tomato melt or sandwich (toasted upon request) 5.5
Cheese, tomato and ham melt or sandwich (toasted upon request) 6.5
Vegemite sandwich 4.0
Sausages and chips 9.0
Chicken schnitzel and chips 9.5
Spaghetti or penne with Bolgnaise, Napoli or boscaiola sauce
(ham, cream and mushrooms) 9.0
Beef burger and chips or salad 9.0
Minute steak and chips 9.0
Battered or grilled fish and chips 9.0
Kids fries 5.0

Dessert

Vanilla ice cream with flavoured topping 4.0

Drinks

Milkshake - chocolate, strawberry, caramel or vanilla 3.5
Smoothie - banana, strawberry or mango 4.0
Orange juice, pink lemonade or soft drink 3.5
Ice cream spider 4.0
Toddlercino 1.5

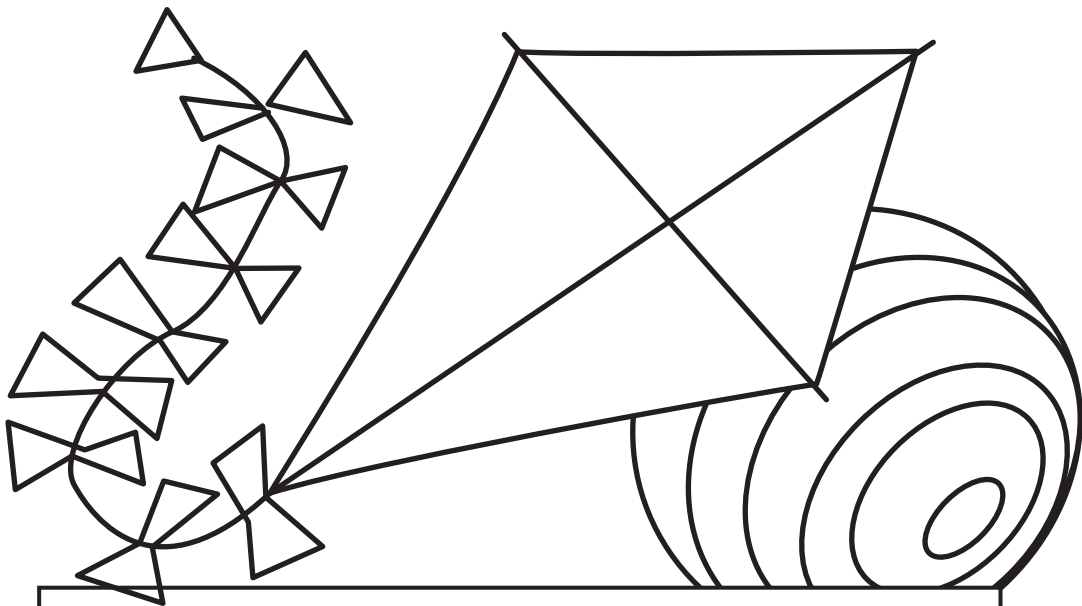

BARBIE
 BATTLESHIP
 CARE BEARS
 GI JOE
 GAME BOY
 HOT WHEELS
 LEGO
 NERF BALLS
 PLAY DOH
 PLAYSTATION
 SILLY PUTTY
 SLINKY
 SPIROGRAPH
 SUPER SOAKER
 TINKERTOYS
 TONKA TRUCKS
 TRANSFORMERS
 TWISTER
 YOYO

R	O	E	T	L	O	T	K	L	F	E	G	R	P	I	H	P
T	E	G	N	P	N	P	I	A	L	I	H	I	S	O	R	I
L	O	K	E	O	S	S	E	N	J	M	H	B	T	L	O	E
Y	I	N	A	L	O	K	S	O	K	S	S	W	O	R	A	Y
A	R	R	S	O	P	C	E	L	E	H	P	H	R	T	L	
A	E	P	I	I	S	U	B	L	L	E	R	O	L	R	Y	S
S	T	Y	L	N	Y	R	T	A	E	A	D	T	A	O	R	E
K	S	A	L	A	O	T	E	L	R	Y	B	N	O	O	K	T
I	I	E	Y	H	A	A	S	P	A	B	S	F	L	Y	R	L
R	W	S	P	B	R	K	R	L	U	F	I	B	R	K	S	M
Y	T	L	U	L	E	N	P	O	O	S	S	E	H	E	R	A
I	Y	I	T	E	H	O	D	R	O	Y	O	Y	B	Y	N	E
P	J	N	T	R	O	T	M	S	R	A	E	B	E	R	A	C
K	M	K	Y	E	O	E	G	A	M	E	B	O	Y	A	S	Y
F	Y	Y	T	S	R	A	S	P	I	R	O	G	R	A	P	H
T	I	Y	L	S	N	O	I	T	A	T	S	Y	A	L	P	A

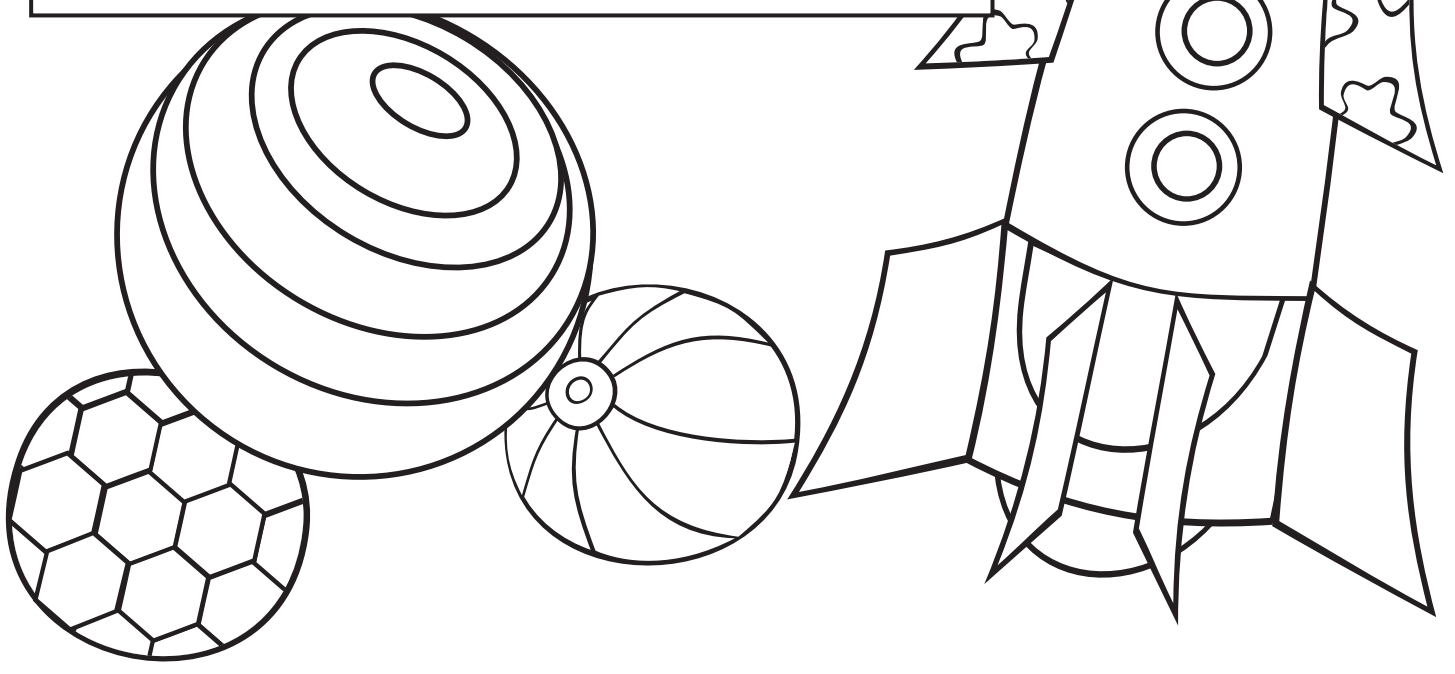



T	V	P	C	E	S	G	T	V	C	A	R	A
T	A	O	B	P	W	Q	N	P	D	K	Z	D
R	F	C	E	A	I	D	W	I	I	N	R	U
S	E	S	I	I	M	R	O	T	L	A	A	L
D	T	W	V	L	S	A	E	C	U	I	S	S
U	N	I	E	M	U	O	I	G	E	E	A	U
O	U	M	C	H	I	B	E	N	V	A	E	S
L	S	M	B	X	T	F	J	A	K	I	N	O
C	Q	I	N	Z	I	R	W	Y	S	X	T	B
F	B	N	R	L	Q	U	K	W	A	T	E	R
F	G	G	F	V	H	S	I	F	R	A	T	S
B	B	E	A	C	H	B	A	L	L	V	P	G
N	L	L	L	E	H	S	A	E	S	R	C	J

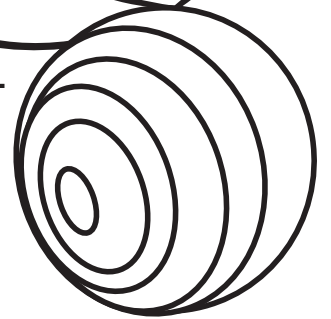
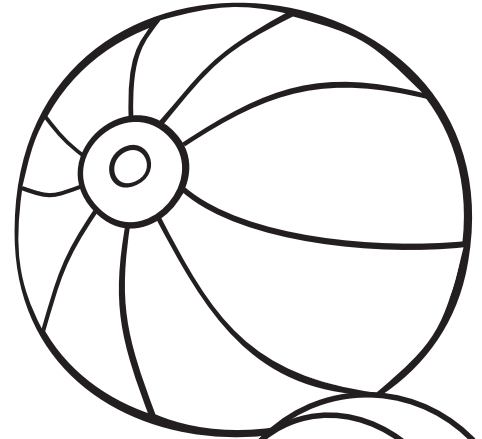

BEACH BALL
 BOAT
 CLOUDS
 KITE
 LIFEGUARD
 OCEAN
 PAIL
 SAILING
 SAND

SEASHELL
 SKY
 STARFISH
 SUN
 SURFBOARD
 SWIMMING
 SWIMSUIT
 WATER
 WAVES

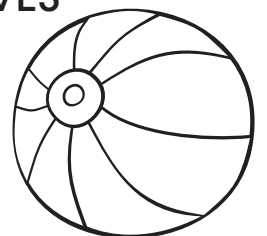
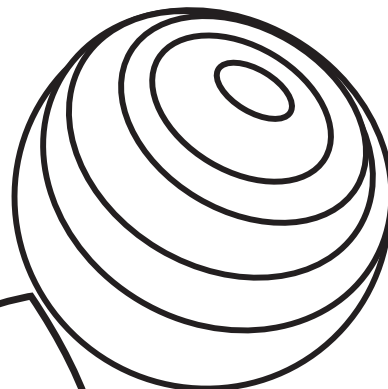

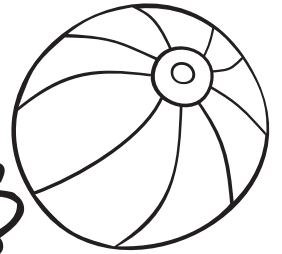

E	H	A	B	F	F	T	P	P	D	A	H	N	I
N	O	A	X	L	R	M	V	D	E	R	I	F	A
A	O	R	M	A	N	R	O	C	P	O	P	O	V
P	P	M	P	U	N	I	C	Y	C	L	E	E	G
C	S	E	C	L	V	X	E	U	T	K	X	P	G
R	Z	R	C	L	O	W	N	S	E	M	H	O	S
E	E	R	E	T	S	A	M	G	N	I	R	R	U
L	E	L	P	M	B	E	G	Q	S	Z	E	T	J
M	I	G	E	E	A	S	S	R	S	L	S	H	K
B	K	O	A	P	C	T	E	R	G	E	T	G	K
O	G	R	N	C	H	G	N	G	O	C	L	I	M
U	S	R	U	S	I	A	U	O	G	H	I	T	A
H	U	L	T	T	I	J	N	F	I	T	T	C	L
O	X	Q	S	L	N	Q	Q	T	L	L	S	Z	P

BEARS
CAGE
CLOWNS
ELEPHANT
FIRE
HOOPS
HORSES
JUGGLERS
LION TAMER
LIONS

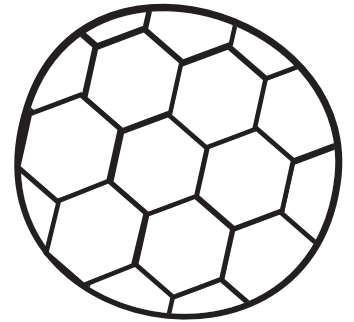

NET
PEANUTS
POPCORN
RINGMASTER
STILTS
TIGERS
TIGHTROPE
TRAPEZE
UNICYCLE

